

Adjustable Self-Service Protector

FINISH:

- Clear Anodized Aluminum
- Brushed Stainless Steel
- Powder Coat:
 - Black
 - Silver

RAL # _____

GLASS (Clear Tempered):

- 1/4" Front - Std
- 3/8" Front
- Frosted

OPTIONS(*):

- End Panel - LT
- End Panel - RT

(*) Not all options available on all models
Contact factory for specific information
For Mounting Options see Mounting Hardware Guide

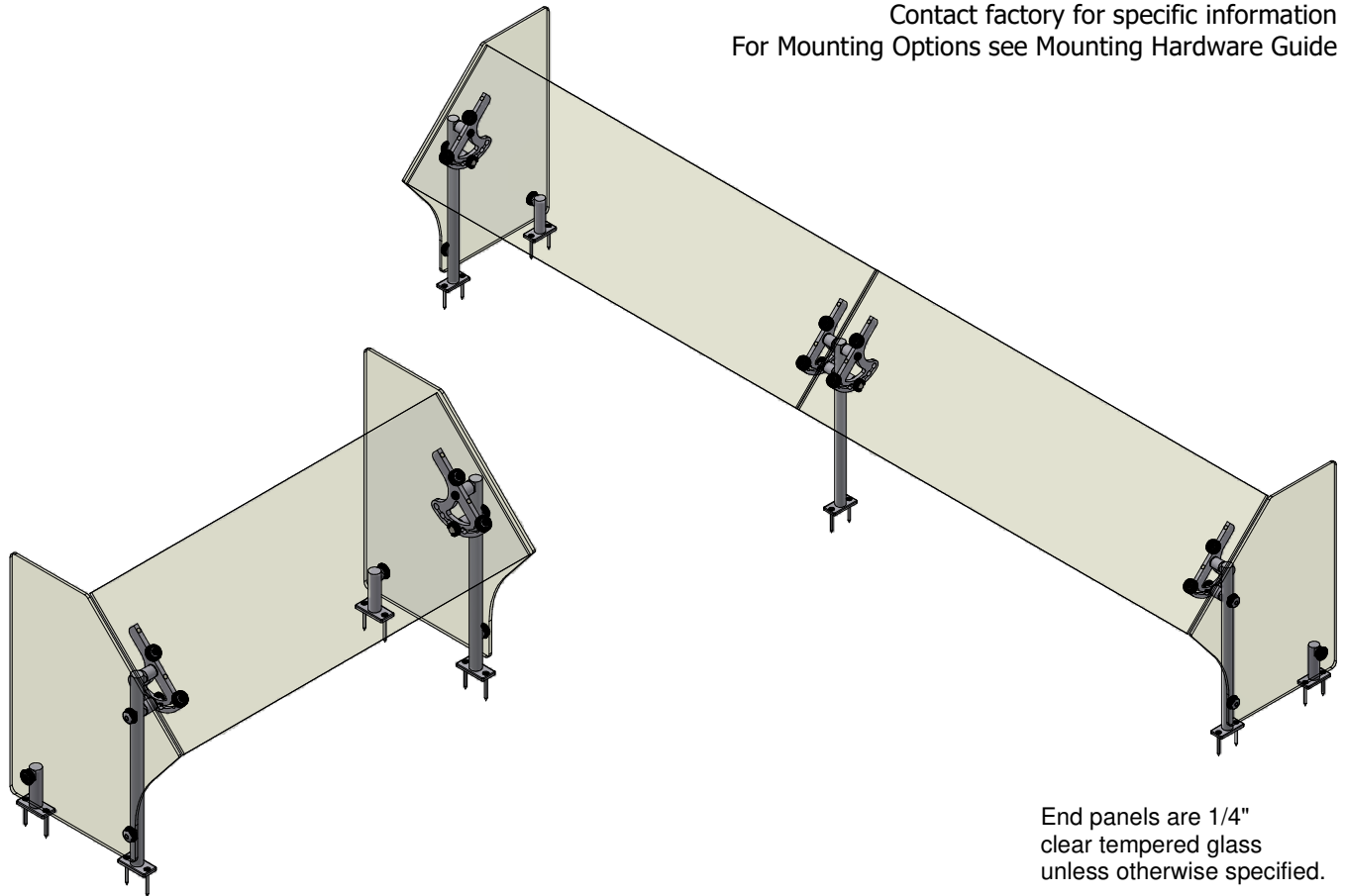

End panels are 1/4" clear tempered glass unless otherwise specified.

- Centerline Dimensions -
L / L1 - 51 3/4" Max (1/4" Glass)
- 63 3/4" Max (3/8" Glass)

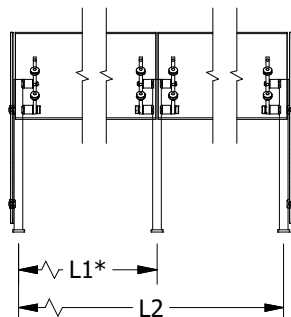
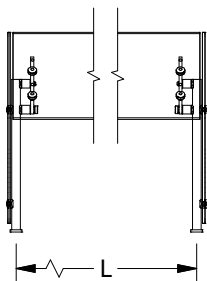

(* - Middle support is centered unless L1 dimension is specified)

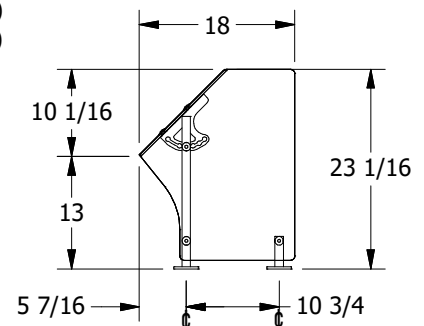

Adjustable Self-Service Protector

GLASS SETTING - 1

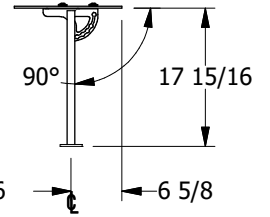
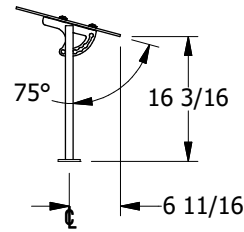
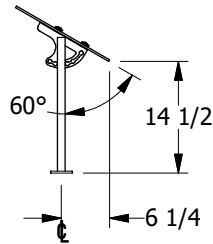
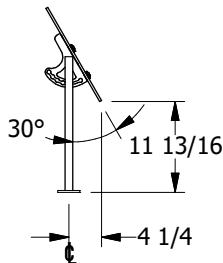
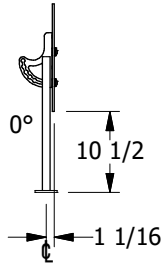
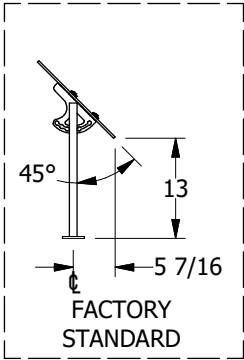

GLASS SETTING - 2

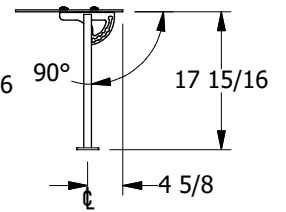
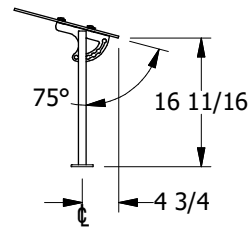
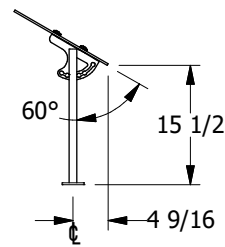
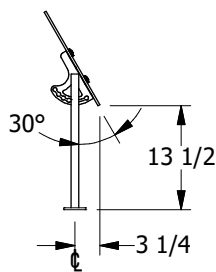
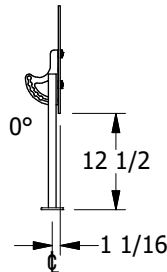
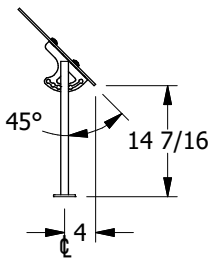

GLASS SETTING - 3

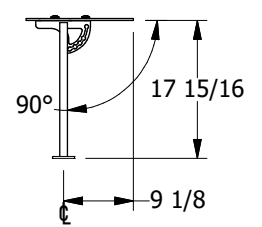
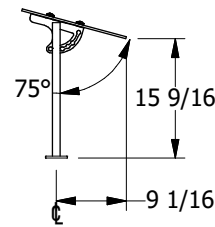
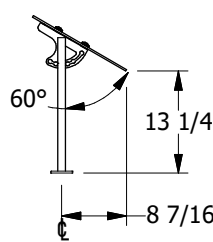
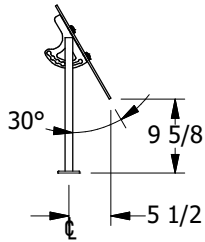
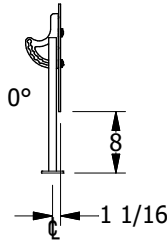
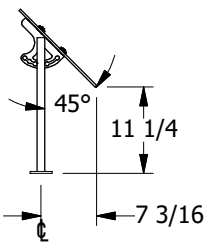

GLASS SETTING - 4

